



Investigation of Anomalous Heat Observed in Bulk Palladium

Gustave C. Fralick (Project Lead),
John D. Wrbanek, Susan Y. Wrbanek,
Janis M. Niedra (ASRC) and Marc G. Millis
with

David J. Spry, Roger Meredith
and Jim Mazor (TFOME/Sierra Lobo)

NASA Glenn Research Center
Cleveland, Ohio



BACKGROUND: “Cold Fusion”?



Headlines 1989

Two electrochemists...

Martin Fleischmann

Stanley Pons

claimed to have tapped nuclear power
in a simple electrochemical cell.

*"It could be the end of the fossil fuel
age: the end of oil and coal. And the
end, incidentally, of many of our
worries about global warming."*

-- Sir Arthur C. Clarke



BACKGROUND: The Advantage of Fusion

Burning Coal:

- $C + O_2 \rightarrow CO_2$ (4 eV)

Fission Power Reaction:

- $^{235}\text{U} + n \rightarrow ^{236}\text{U}$
 $\rightarrow ^{141}\text{Ba} + ^{92}\text{Kr} + 3 \cdot n$ (170 MeV)

Fusion Processes:

- $D + D \rightarrow T$ (1.01 MeV) + p (3.02 MeV)
- $D + D \rightarrow ^3\text{He}$ (0.82 MeV) + n (2.45 MeV)
- $D + D \rightarrow ^4\text{He}$ (73.7 keV) + γ (23.8 MeV)
- $D + T \rightarrow ^4\text{He}$ (3.5 MeV) + n (14.1 MeV)
- $D + ^3\text{He} \rightarrow ^4\text{He}$ (3.6 MeV) + p (14.7 MeV)
 – $D = ^2\text{H}$, $T = ^3\text{H}$
- Fusion is at least 13% more productive per mass of fuel (without the nasty waste products)

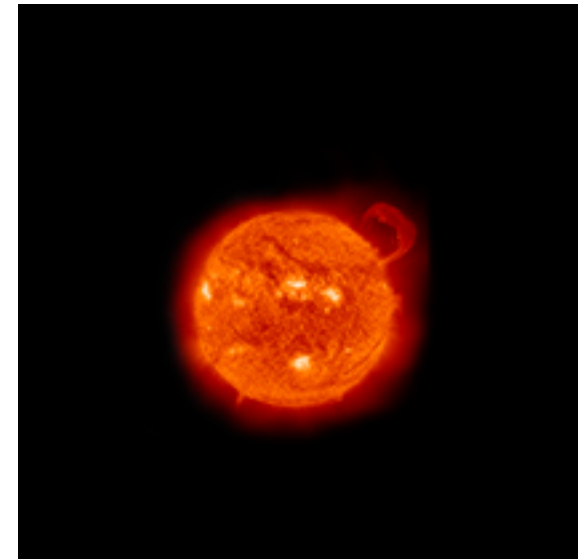



BACKGROUND: 1989 Cold Fusion Experiment

- Tested non-electrochemical variant of “Cold Fusion” – where Deuterium (D_2) gas used with palladium (Pd) filter
- Used Pd filter from hydrogen purifier
- Gas is “loaded” and then “unloaded” from palladium, while monitoring purifier temperature and neutrons.
- Compared to Hydrogen gas as the experimental control.



Results

- Published: *Fralick, Decker, & Blue (1989) NASA TM-102430*
- $15^{\circ}C$ increase in purifier temperature consistently seen with D_2 that was not seen with the H_2 control when gasses were unloaded from the purifier.
- Neutron detector counts did not differ significantly ($\leq 2\sigma$) from background in any run (Monitored with BF_3 w/ Polyethylene [“Snoopy”] detectors).

BACKGROUND: Purifier Schematic

- Johnson Matthey HP Series palladium membrane hydrogen purifier
- Used in the semiconductor industry and applications where ultra-high purity hydrogen is required (to 99.9999999%)
- An at-hand substitute for a palladium electrolytic cell



Flow Diagram HP Series

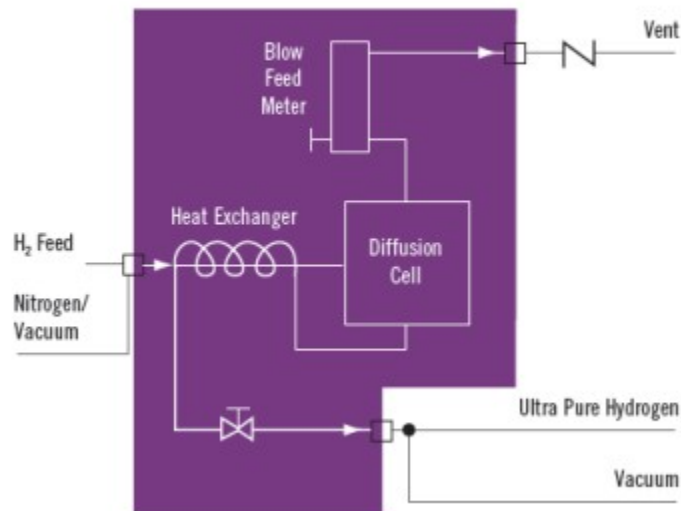



BACKGROUND: Changes from 1989 to 2009

- Previous NASA experiment (Fralick, et al.; 1989) looked for neutrons (saw none) – but saw anomalous heating
- After 1989, Cold Fusion research evolved into research in “Low Energy Nuclear Reactions” (LENR), primarily at U.S. Navy, DARPA & various Universities
- Some recent LENR theories suggest He-3,-4 generation or transmutations occurring in PdH/D is the cause of anomalous heating
- **2009: NASA IPP-sponsored effort to:**
 - Repeat the initial tests to investigate this anomalous heat
 - Apply GRC’s instrumentation expertise to improve the diagnostics for this experiment
 - Establish credible framework for future work in LENR



APPROACH: Flow System Schematic

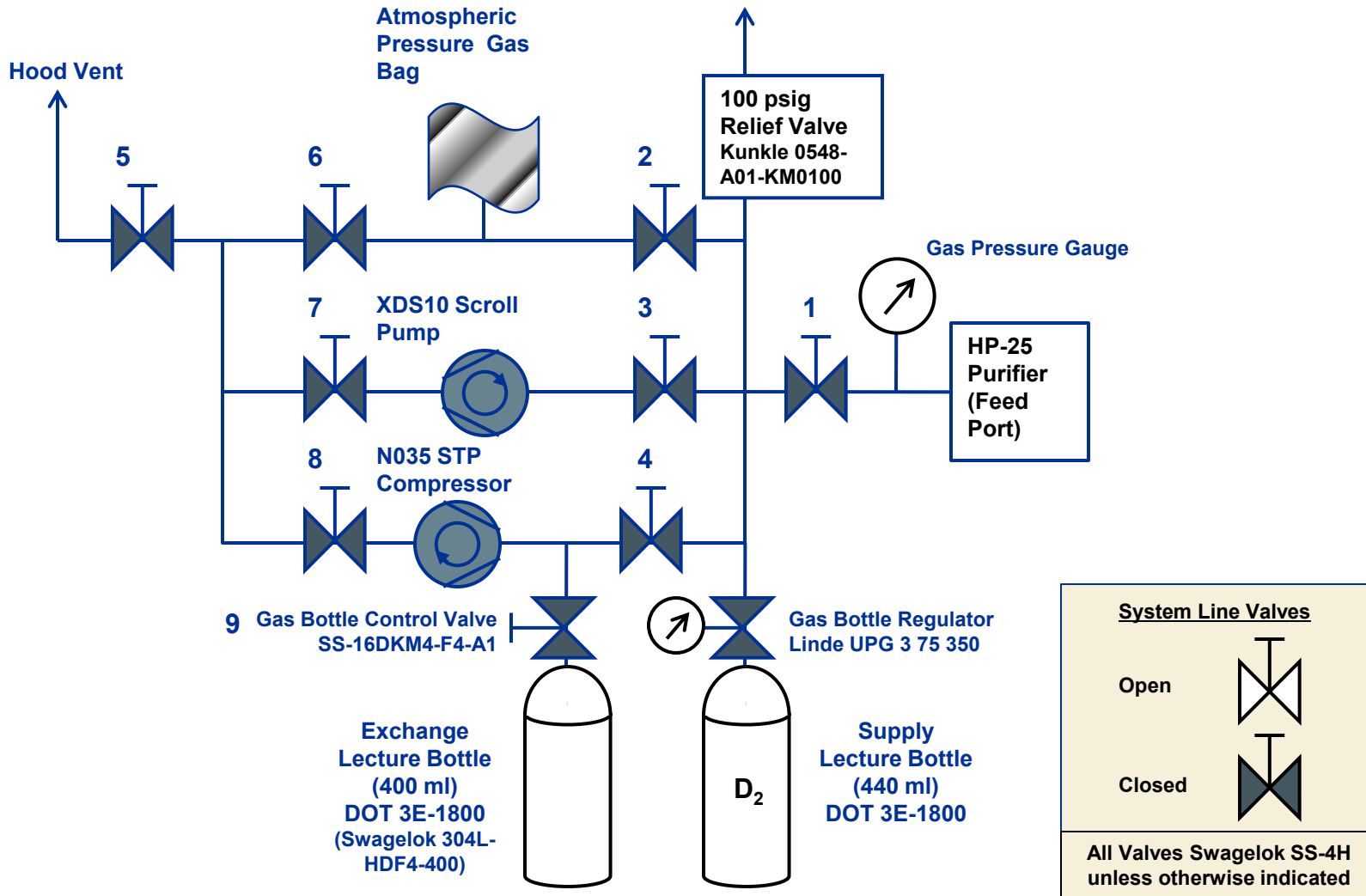

APPROACH: 2009 Test Apparatus

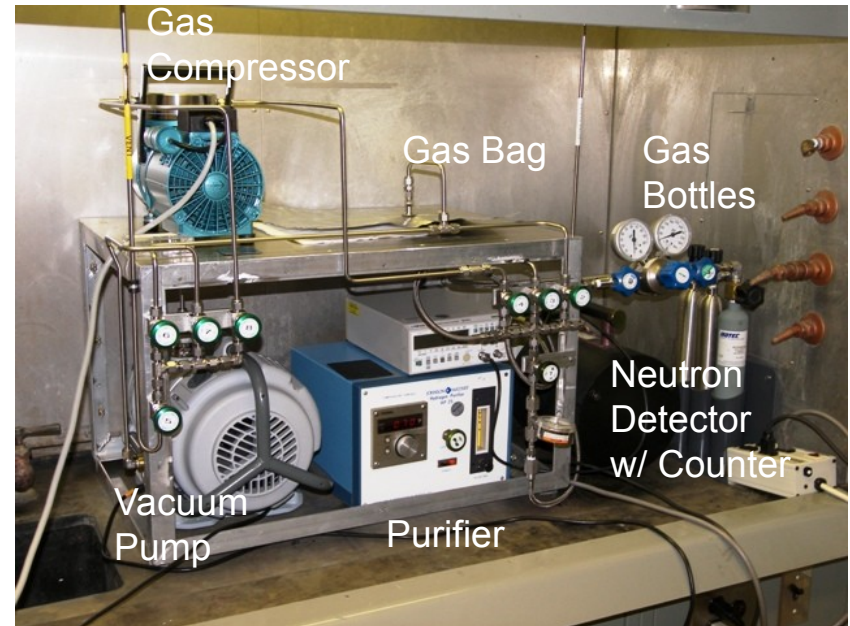
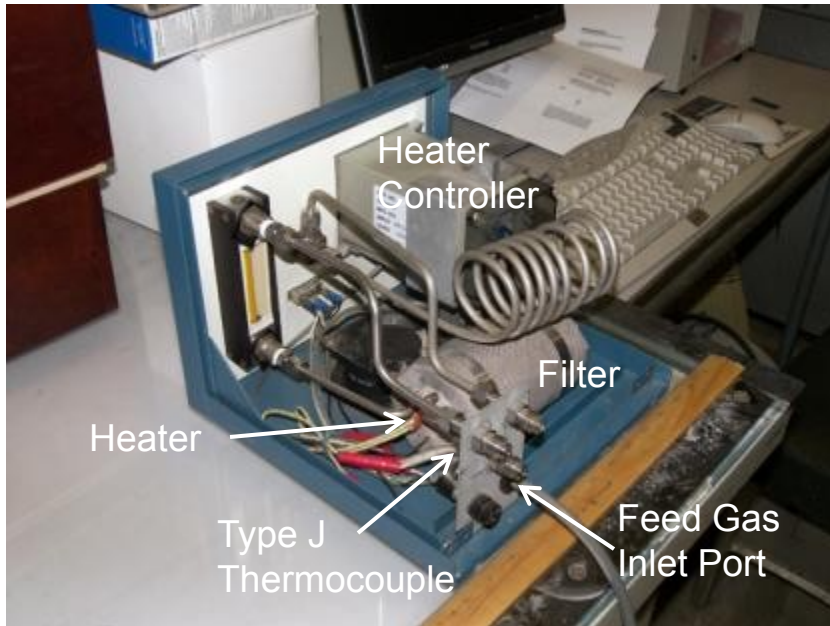

- Johnson Matthey HP-25 hydrogen purifier
 - Purifier Filter contains a ~50g heated Pd-25%Ag membrane
- Load Filter by flowing hydrogen gas into the purifier
- Unload Filter by pumping the gas out of the purifier into a sample bottle
- Turn off filter heater for a time when Loading & Unloading
- Monitor changes in temperature, neutron/gamma background
- Repeat with deuterium gas; Compare results

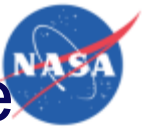

RESULTS (Preliminary): Temperatures vs. Time

Loading

Unloading

Hydrogen

Observed Temperature for H2 Load

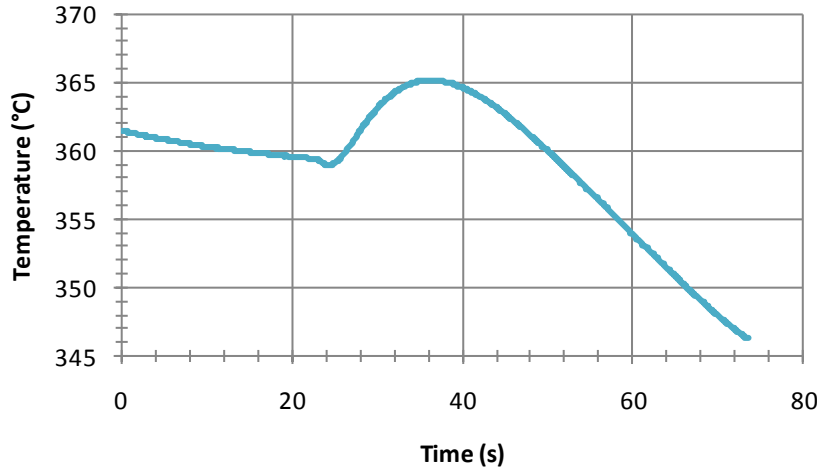

Observed Temperature for H2 Unload

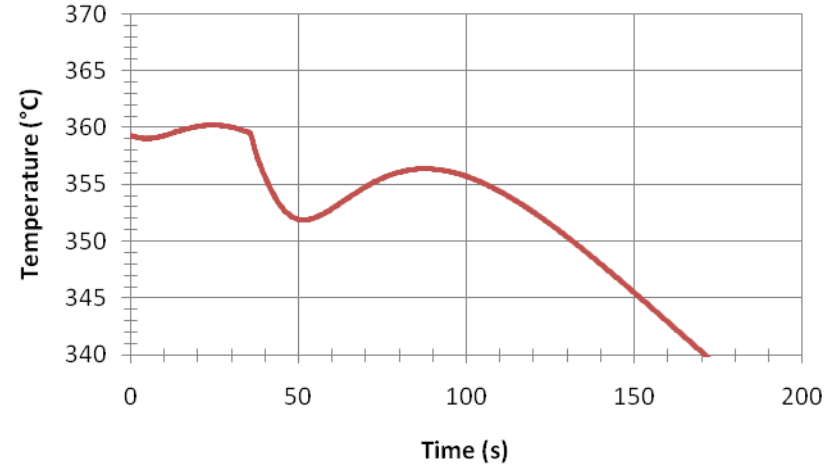

Deuterium

Observed Temperature for D2 Load

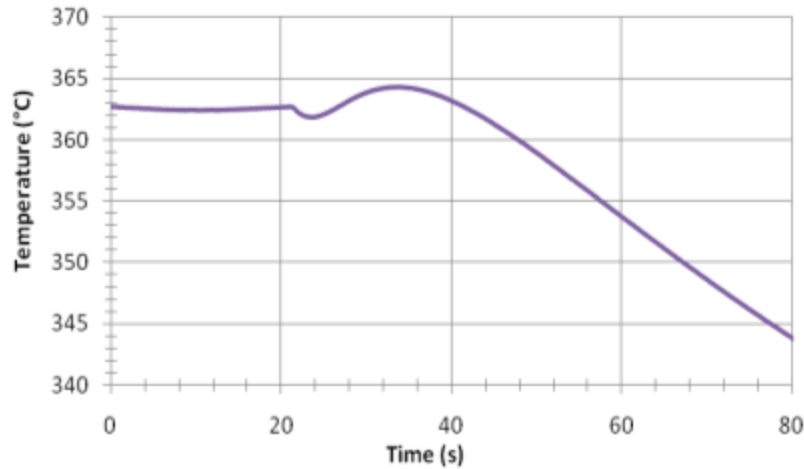

Observed Temperature for D2 Unload

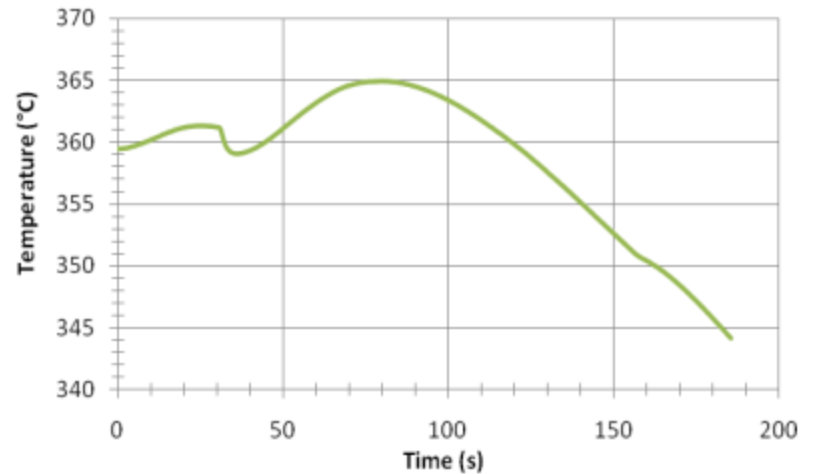



The Path Forward

- More loading/unloading data on the temperature evolution of the loading/unloading process should be collected
- Analysis of the gas samples collected should be performed to look for evidence of tritium or helium
 - Mass spectrum analysis and optical emission spectrum analysis should be able to identify gas species in the samples
 - Existence of either in the sample would indicate a nuclear origin for the anomalous heating
- Further examination of the thermodynamics of hydrogen absorption in palladium should be pursued to fully quantify the extent of the observed heating effects
- Improve experiment controls:
 - Upgrade Purifier heater control
 - Improve loading/unloading process timing
 - Fabricate in-house palladium samples
 - Improve neutron and gamma radiation detection



References

- Fralick, Gustave C.; Decker, Arthur J. and Blue, James W.: “Results of an Attempt to Measure Increased Rates of the Reaction ${}^2\text{D} + {}^2\text{D} \rightarrow {}^3\text{He} + \text{n}$ in a Nonelectrochemical Cold Fusion Experiment,” NASA TM-102430 (1989).
- Liu, Bin; Li, Xing Z.; Wei, Qing M.; Mueller, N.; Schoch, P. and Orhre, H.: “‘Excess Heat’ Induced by Deuterium Flux in Palladium Film.” *The 12th International Conference on Condensed Matter Nuclear Science*, Yokohama, Japan, Nov. 27 – Dec. 2, 2005.
- Li, Xing Z.; Liu, Bin; Tian, Jian; Wei, Qing M.; Zhou, Rui and Yu, Zhi W.: “Correlation between abnormal deuterium flux and heat flow in a D/PD system,” *J. Phys. D: Appl. Phys.* **36** 3095-3097 (2003).
- Li, Xing Z.; Wei, Qing M. and Liu, Bin: “A new simple formula for fusion cross-section of light nuclei” *Nuc. Fusion* **48** 125003 (2008).
- Biberian, J.P. and Armanet, N.: “Excess Heat Production During Diffusion of Deuterium Through Palladium Tubes” *8th International Workshop on Anomalies in Hydrogen/Deuterium Loaded Metals*, Sicily, Italy, 2007.